

12-Bit CVBS AFE

Overview

This 1-channel CVBS analog front-end (AFE) is for digital television applications. It is a 1.8V/0.8V 12-bit 57.272MS/s 1-channel A-to-D for composite (CVBS) video interfaces including ADC, clamps, analog buffers, analog MUX and video PLL.

Key Features

- 14nm Low Power Plus (LN14LPP) CMOS device technology
- 1.8V, 0.8V dual power supply
- Resolution : 12-bit
- Conversion Rate : 57.272 MS/s
- Input Range : 1.0Vpp
- SNDR : > 50dB
- Metal Option: 7U1x_2T8x_LB
- PLL reference clock input frequency : 24.576 MHz
- 1-channel 2 analog inputs (CVBS1, CVBS2 with MUX)

Deliverables

- DataSheet
- UserGuide
- Verilog model
- Timing DK
- CDL netlist
- Layout (GDS2 or OAS)

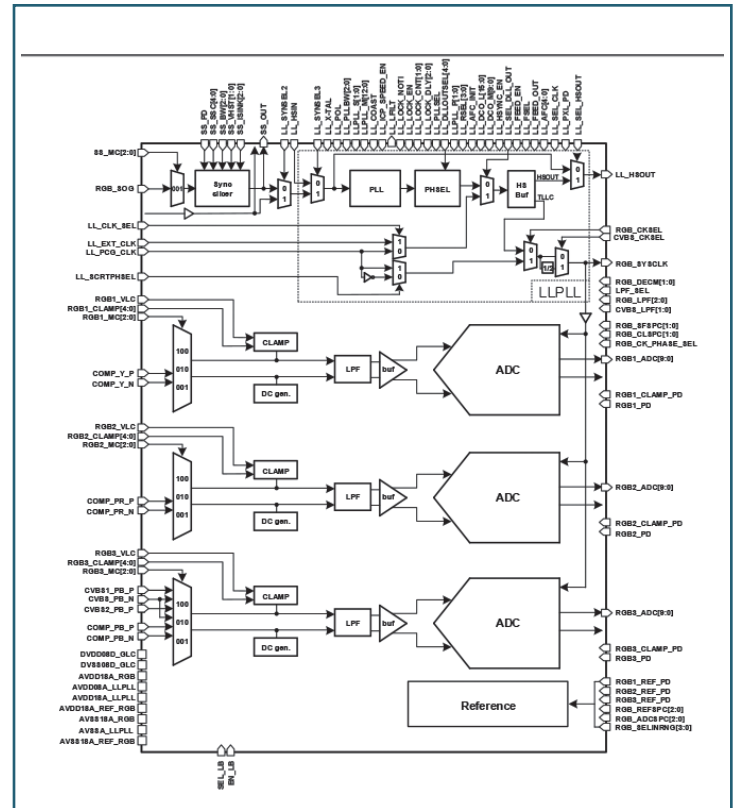

Applications

- Mobile/Consumer/Network/IoT

SAMSUNG Foundry

For more information, please contact us at IP@silvaco.com.

©Copyright Silvaco, Inc. All rights reserved. Silvaco is a registered trademark of Silvaco, Inc. Samsung Foundry is a trademark of Samsung Electronics Co. Ltd. All other names mentioned herein are trademarks or registered trademark of their respective owners.

All information provided is for reference purposes only and may be changed without notice.

SILVACO

HEADQUARTERS

2811 Mission College Boulevard, 6th Floor
Santa Clara, CA 95054

Phone: 408-567-1000

Fax: 408-496-6080



CALIFORNIA

sales@silvaco.com

408-567-1000

MASSACHUSETTS

masales@silvaco.com

978-323-7901

TEXAS

txsales@silvaco.com

512-418-2929

JAPAN

jpsales@silvaco.com

EUROPE

eusales@silvaco.com

FRANCE

eusales@silvaco.com

KOREA

krsales@silvaco.com

TAIWAN

twsales@silvaco.com

SINGAPORE

sgsales@silvaco.com

CHINA

cnsales@silvaco.com

WWW.SILVACO.COM

Rev 080819_02

71127